

# Fama®

A QUALIDADE FAZ A MARCA

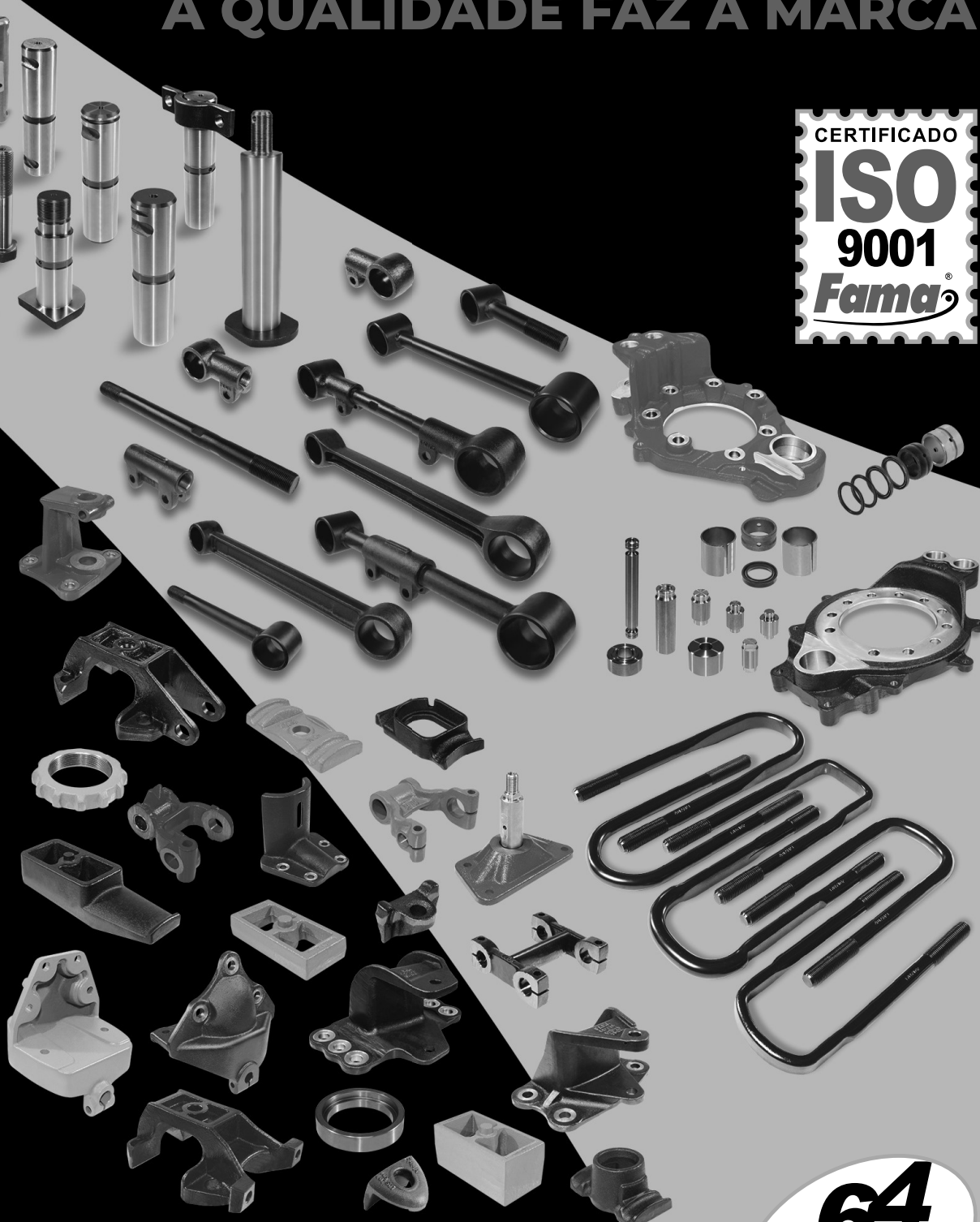

**AUTOPEÇAS**



**2024**





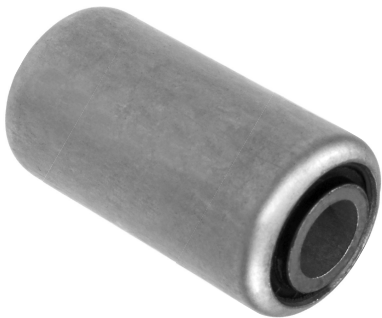

109.399 = BUCHA SILENCIOSA  
DIANTEIRA 12.170 A 16.220



109.400 = BUCHA SILENCIOSA  
TRAS. (TENSOR) 12.170 A 16.220  
(52 X 22,3)



308.403 = ASSENTO FX. MOLA  
TRASEIRO 12.170 A 16.220



500.403 = GUIA GRAMPO TRAS.  
12.170 A 16.220  
Nº. ORIG. (1.658.7817)

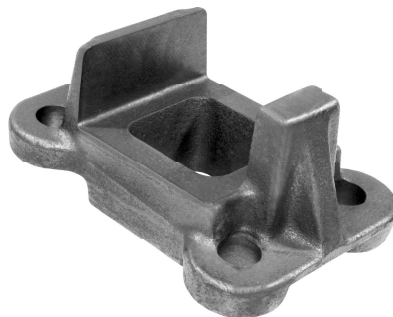

598.400 = SAPATA DE GRAMPO  
12.170 A 16.220



687.402 = SUPORTE DA MOLA  
TRAS. P/ DIANT. 12.170 A 16.220



687.403 = SUPORTE DA MOLA  
TRAS. P/ TRAS. 12.170 A 16.220



687.404 = SUPORTE DA MOLA  
AUXILIAR 12.170 A 16.220

MOLAS E ARTEFATOS



A QUALIDADE FAZ A MARCA

## Conheça nossa Linha de Molas Planas



Diversos Modelos de Molas Parabólicas e Convencionais das Principais Marcas



# COMPLEXO INDUSTRIAL

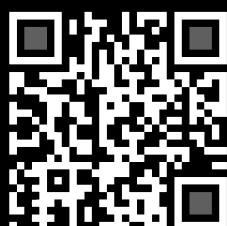
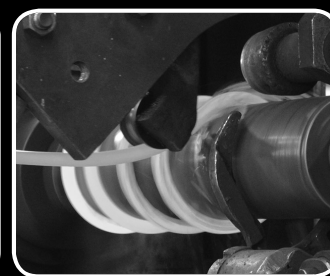
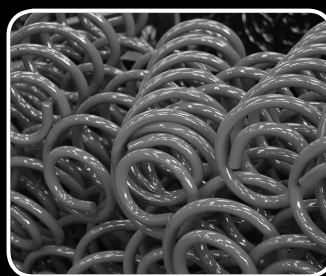
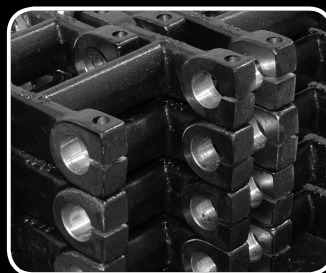
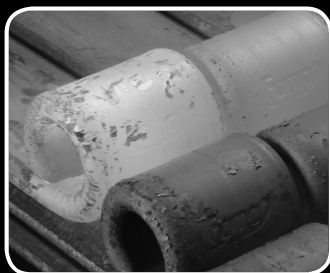

Rod. BR 376 - Km 232, s/n° - Parque Industrial Zona Oeste II  
Saída p/ Maringá - Caixa Postal 917 - CEP 86800-762  
Apucarana - Paraná - Brasil



ACESSE NOSSOS  
CATÁLOGOS

(43) 3420-9000 comercial@molafama.com.br  
fama.molas molafama www.molafama.com.br